

Section 3 – Performance Characteristics

3.1. Dynamic Range

3.1.1. Definition

Dynamic range is the measured values over which a transducer is intended to measure, specified by upper and lower limits. The lower limit, when dynamically (ac) coupled, is a few microvolts of noise generated by the silicon gauges and other internal components. When measuring statically (dc coupled), the lower limit will be determined by the zero measurand output and the long term, very low frequency thermal zero drift.

3.1.2. Range

The range of the pressure transducer specifies the recommended maximum peak pressure level for optimum linear response. Most Kulite pressure transducers maintain good linearity up to 3 times the range, and specifications are provided for extended range. This is intended as a safety margin, not for normal use.

3.1.3. Overrange

Above the range, nonlinearity increases, but the transducer continues to operate. As a single-degree-of-freedom system the mechanical response of the diaphragm to an applied pressure is frequency-dependent. Do not apply full scale pressure at frequencies above 30% of resonance frequency. This may excite the diaphragm resonance and, cause erroneous data or lead to diaphragm failure. A pressure "snubber," in the form of a small orifice, may be used to attenuate high frequencies and pressure spikes.

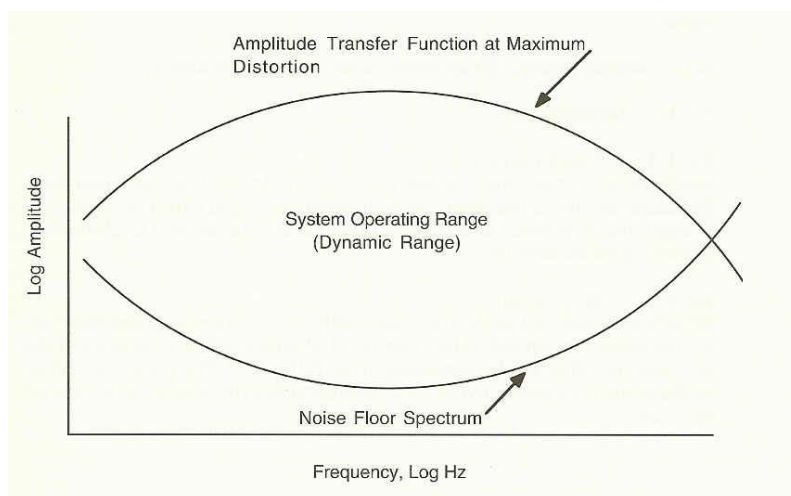

Figure 3-1: Instrument System Operating Range

3.2. Sensitivity

The sensitivity of a transducer is defined as the ratio of its electrical output to its mechanical input. In the case of piezoresistive pressure transducers, it is expressed as voltage per unit of pressure at the rated excitation. Units of millivolts per psi (mV /psi) are used because Kulite pressure transducers are calibrated and recommended for operation at a specified and fixed excitation voltage of 10.00 volts dc.

3.2.1. Sensitivity Calibration

Each Kulite transducer is provided with a sensitivity calibration as measured by a readout device with a high input impedance (loading effects are discussed later). The transducer is operated at rated

electrical excitation. The sensitivity is expressed in mV /psi and is numerically equal to root mean square (rms) mV per rms psi and peak mV per peak psi

3.2.2. Polarity

For many measurements, it is necessary to know the polarity of the system output signal relative to the direction of pressure on the transducer. To determine this, the polarity of the transducer output and the input-output phase relationship of the amplifier must be known.

Unless otherwise specified, all Kulite pressure transducers produce a positive output signal when the pressure increases. Polarity of the excitation voltage must be applied in accordance with the specifications on individual transducer data sheets. Kulite maintains standard strain gage practice with colour codes of red for positive excitation, black for negative excitation, green for positive output signal, and white for negative output signal.

3.3 Nonlinearity, Hysteresis & Nonrepeatability

3.3.1 Definitions

3.3.1.1 Linearity

Non-linearity (sometimes called linearity) is defined as the maximum deviation of the calibration curve (output vs. input) from a specified straight line, expressed as a percent of full scale output, and measured on increasing measurand only.

3.3.1.2. Hysteresis

Hysteresis is defined as the maximum difference between output readings for the same measurand value, one point obtained while increasing from zero and the other while decreasing from full scale. The points are taken, on the same continuous cycle. The deviation is expressed as a percent of full scale.

3.3.1.3. Non-repeatability

Non-repeatability (sometimes called repeatability) is defined as the ability of a transducer to reproduce output readings when the same measurand value is applied to it consecutively, under the same conditions, and in the same direction. It is expressed as the maximum difference between output readings as a percent of full scale.

3.3.2. Non-linearity

Although a piezoresistive transducer is theoretically linear down to zero pressure, a practical lower limit is imposed by its noise level. As in all electrical conductors, the thermally-induced random motions of free electrons cause noise; in addition, the current flow through the diffused gage elements causes some additional noise having the characteristics of Schottky, or shot, noise. As a result, both

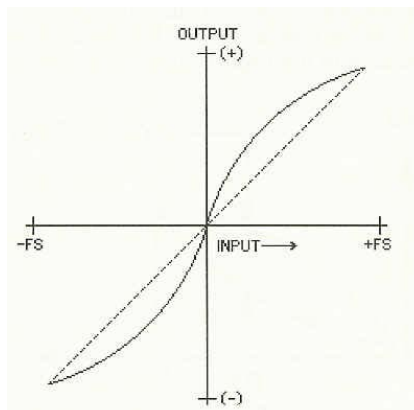

Figure 3-2: Input to Output Curve

the diffused and SOI pressure transducers have a wide band noise characteristic of about 5 microvolts RMS, measured at 20°C. This corresponds to about 1×10^{-4} psi for a 2 psi full scale transducer. Because this noise level is very small, the lower limit of dynamic range is usually a function of the noise characteristics of the signal conditioning and power supply equipment used with the transducer.

Single crystal silicon is a very good spring material, having essentially no plastic zone to its stress-strain curve and very low hysteresis. Because the input pressure to these transducers is supported only by the silicon element, these transducers become highly non-linear before burst is reached. Although each transducer is identified with a particular full scale range, there is no absolute end to the scale (with the exception of burst). One may elect to use a transducer at some pressure above full scale, or well below full scale, depending on the requirements of the application. Each transducer is tested prior to shipment to a maximum limit for combined linearity and hysteresis to the "defined" full scale level, and for operation to a specified overrange level, typically 2 times full scale.

The linearity plotted below and which is shown on the specifications for the transducers is the "independent linearity". This is defined as the maximum difference between the calibration point and the linear regression line (least squares fit) drawn through the points for increasing measurand, zero to + full scale. Numerically, this is usually about one-half the value when using an end-point, or terminal based, linearity definition.

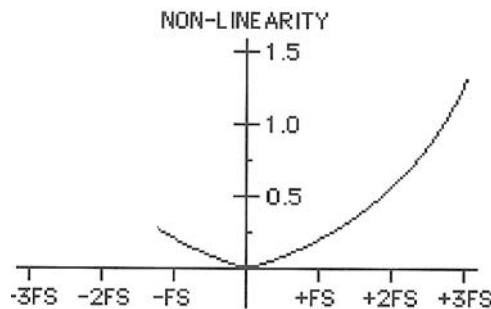

Figure 3-3: Independent Linearity Curve

3.3.3. Hysteresis

Because of the excellent elastic characteristics of silicon, the hysteresis of these gages is usually very small, most of the time under 0.1% of full scale, and often as low as 0.03%. As such, the specifications have simply been stated by indicating typical values for linearity and hysteresis, and then indicating a maximum limit for the two combined.

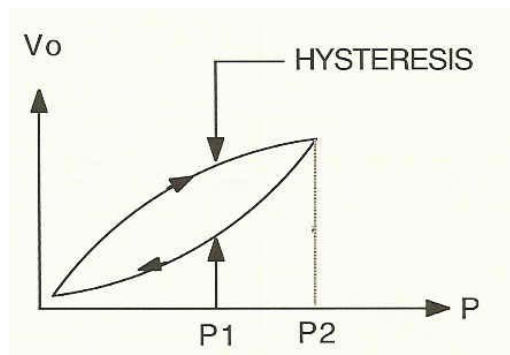

Figure 3-4: Transducer Hysteresis

3.3.4. Non- repeatability

Non-repeatability (sometimes repeatability) is the ability of a transducer to repeat output readings when the same pressure is applied to it consecutively under the same conditions, and in the same direction as shown below. It is expressed as the maximum difference between output readings as a percent of full scale output (%FSO). Two calibration cycles are used to determine non-repeatability.

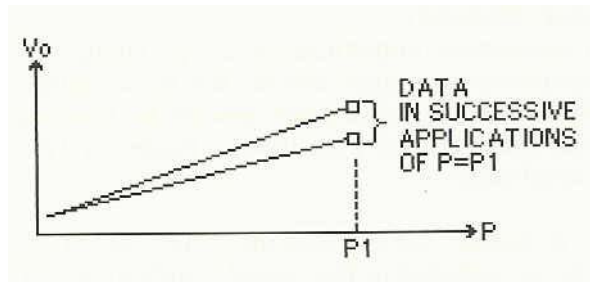

Figure 3-5: Transducer Non-repeatability

3.3.5. Combining Nonlinearity, Hysteresis, and Non- repeatability

Combined nonlinearity, non-repeatability, and pressure hysteresis is the maximum RSS (root-sum-square) average of the three independent parameters discussed above. This is the “total error band” calculated as the RSS average of three independent measurements.

3.4. Zero Measurand Output (ZMO)

This characteristic is often called zero balance, zero offset, or zero pressure output. Zero Measurand Output is expressed in millivolts at the output of the transducer under room conditions with full rated excitation, but with no pressure applied to the transducer. For an absolute pressure transducer, this means the output when measuring an absolute vacuum.

Although the resistance elements in the bridge of a transducer are closely matched and compensated during manufacture, slight differences in resistance will exist. The differences result in a small offset or residual dc voltage at the output of the bridge. This residual voltage is called Zero Measurand Output. Circuitry within associated signal conditioning instruments typically provides compensation or adjustment of the electrical zero.

3.4.1. Mounting Effects

Zero offset can be increased by improper transducer mounting of ultra miniature pressure transducers. Any stresses placed on or near the diaphragm will result in changes in the zero offset. However in the case of Kulite threaded transducers, over-tightening has no effect on the zero measurand output and will usually result in physical damage to the threads or the transducer body. Threaded devices have a recommended installation torque specified on the calibration sheet.

3.4.2. Warm-up

Warm-up time is the period of time, from application of excitation voltage, required to assure that the transducer will perform within all specified tolerances. The zero offset will move to its final value while the pressure transducer is being "warmed up." Kulite's unique diaphragm design provides very fast warm-up stabilisation. Kulite's pressure transducers typically have warm-up times of one millisecond or less to achieve less than 1 % deviation from long term performance. This characteristic enables the power supply to a pressure transducer to be turned on only for the duration of the measurement which, for battery powered applications, is advantageous as it maximises battery life.

3.4.3. Thermal Stability

Since both zero measurand output and sensitivity change with temperature, a stable temperature environment assures the most stable measurements. However, Kulite's design has been shown to have only very small output shifts even under severe conditions.

When making dynamic measurements, the output of the pressure transducer can be ac coupled to the signal conditioner. This completely eliminates the zero offset, greatly reduces thermal zero shift, and provides a controllable high pass filter. Of course, static or steady state measurements are no longer possible.

3.4.4. Effect of Overpressure

Kulite pressure transducers will survive overpressures of up to 2x full scale without any measurable change in calibration. Burst pressure specifications are provided on the data sheets, and are discussed elsewhere in this text. Because the Kulite silicon diaphragms are very elastic until they fracture, if they are not broken, it is unlikely that the transducer has been damaged.

3.5. Phase Shift

The transducers themselves are very lightly-damped dynamic systems with essentially no phase shift. Therefore, phase shift of the transducer is negligible. However, the damping characteristics of the measured medium will affect the response of the diaphragm. Also, as discussed previously, connecting plumbing may have damping effects between the measurement point and the transducer, thus causing some phase shift. Electrical characteristics of the transducer's integral compensation and balancing components are all resistive, so they cause no phase shift. Typical signal conditioning will have either 0 or 180 degree phase shift, depending on how many amplifier stages are included and their characteristics.

3.6. Input and Output Resistance

The primary uses of these specifications are to calculate excitation current requirements and to assure that the bridge is not open or shorted.

The input and output resistances of piezoresistive pressure transducers are specified on the individual data sheets. For an equal-arm four-element Wheatstone bridge, the input and output impedances are equal and are in the order of 1,000 ohms. However, temperature compensating and zero balance resistors are connected in series with the sensing elements. These additional resistors will usually result in slightly differing input and output resistance. These full-bridge transducers have series resistors for thermal sensitivity compensation located external to the bridge, so that input resistance is approximately 1.5 to 2 times the output value.

For best results, the readout instrumentation input impedance should be at least 1 Megohm. For an impedance of 20 times the output impedance of the bridge, the sensitivity is reduced by 5%. With an input impedance of 50 times, the reduction is 2% and an input impedance of 100 times yields a 1% reduction.

Actual values of input and output impedance are recorded on each calibration sheet and are a very simple and convenient means of verifying the health of any transducer.

3.7. Thermal Sensitivity Shift and Zero Shift

Thermal sensitivity shift and thermal zero shift define the effects on sensitivity and ZMO of operation at operating temperatures other than a normal ambient temperature 24°C. Thermal zero shift is specified in terms of the maximum change of ZMO from its room temperature value, as a percent of full scale output.

The operating and environmental temperature ranges for piezoresistive pressure transducers are specified on individual data sheets. The operating range indicates the limits within which the transducer will not be damaged. The compensated range indicates the limits within which the transducer will operate with predictable characteristics or for which the transducer has been compensated.

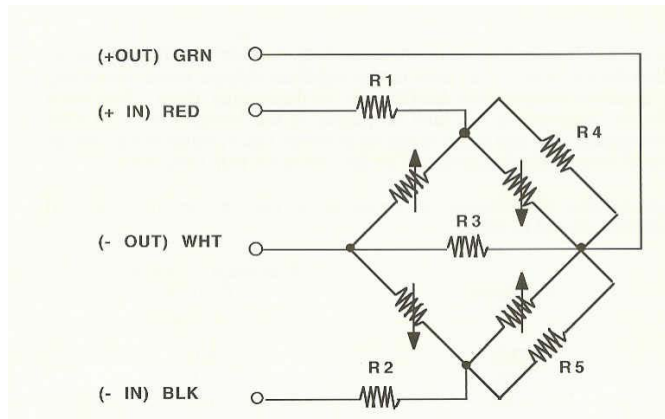

Figure 3-8: Schematic of 4 Gauge Bridge Showing Resistors for Span & Zero Thermal Compensation

3.7.1. Thermal Sensitivity Shift

Sensitivity Shift - The temperature compensation utilised for standard production units typically reduces the thermal sensitivity shift to a maximum of $\pm 1\%$ of output per 55°C change in operating temperature. Tighter specifications can be met, if required, and the compensated temperature range can be reduced, expanded and moved up or down. Calibration data can also be supplied at any specified temperature within the environmental range, even beyond the compensated range.

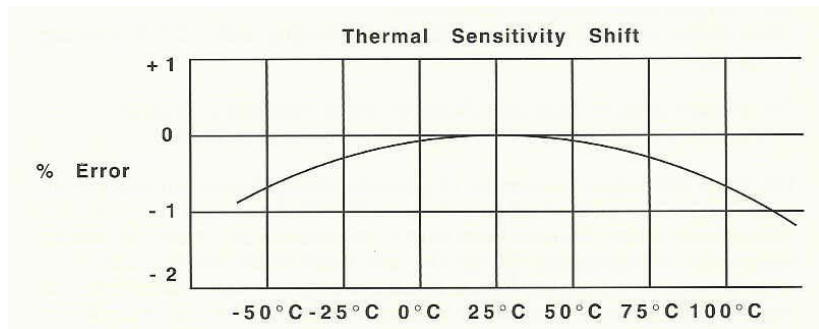

Figure 3-6: Typical Thermal Sensitivity Shift

3.7.2. Thermal Zero Shift

The changes in resistance of the various elements caused by temperature changes is rarely balanced. Therefore, as temperature changes, the bridge balance changes, resulting in a change in ZMO. The plot below shows an example of typical thermal zero shift. This is usually the largest component of thermal error, especially when measuring to only small fractions of full scale: Thermal ZMO shift is an absolute percentage of FSO, and is therefore, a more significant percentage of the measured value at fractions of full scale.

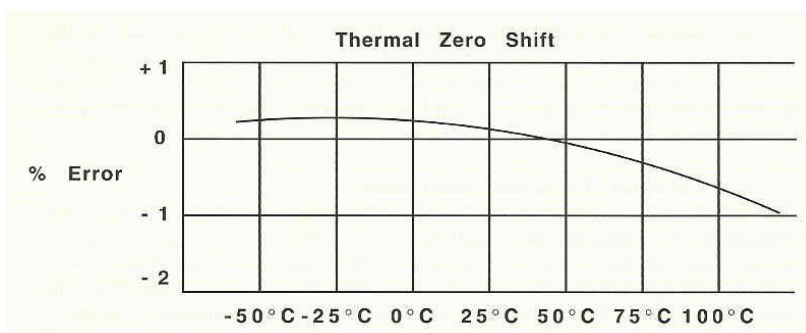

Figure 3-7: Typical Thermal Zero Shift

Because of variations in material properties, processes, and dimensions, the performance of a population of units of a given design will scatter about the nominal. To provide the lowest effect of temperature, Kulite measure the performance of each transducer during the manufacturing process, and resistance values are chosen to compensate for changes with temperature. The bridge circuit employed in these transducers is shown below. The resistance in series is used to reduce the sensitivity variation with temperature. Note that a resistor may be placed in both the positive and negative power supply lines; this is done to retain balance to aid in rejection of common mode noise. The resistances in series and parallel with one arm of the bridge correct for bridge unbalance and balance change (zero shift) with temperature.

3.7.3. Thermal Transient Response

The compensated temperature range is the range in which the pressure transducer will meet the specifications for zero and sensitivity shift as given in the data sheets. Above and below this range, the transducer will continue to operate but the specification will gradually increase from the data sheet values. The transducer is compensated for equilibrium values of temperature and not for very fast temperature changes, pulses or excursions. If the pressure transducer is compensated from 0°C to 300°C and the actual 300°C differential occurs in a rapid excursion, the device must be allowed to come to an equilibrium temperature before it will meet the listed specifications. Compensation is only valid for equilibrium or slow changes in temperature, not for thermal shocks.

Thermal transient response is the output of the transducer when subjected to a step-function temperature change from room temperature to the upper limit of the operation range.

3.8. Photo Flash Response

Photo flash response is the output of a simple diffused silicon technology transducer when subjected to the flash from a photographic flash bulb approximately two feet in front of the transducer. Since Kulite developed the dielectrically isolated integrated sensor design, photo-flash response has been eliminated.

The photosensitivity of silicon quite often will render diffused silicon diaphragm pressure transducers susceptible to radiation. The resulting transient output can be significant for applications where high intensity light can impinge on the diaphragm (such as in explosions or in engine combustion chambers). Several techniques have been devised to minimise this effect, such as covering the diaphragm with an opaque material. However because of the added mass, the diaphragm coating does adversely affect the acceleration sensitivity and frequency response of the transducer.

3.9. Transducer Resonant Frequency

Resonant frequency is the frequency of pressure application at which the transducer responds with maximum output amplitude.

The resonant frequency of a piezoresistive transducer is a function of its mechanical characteristics. Although it is actually a higher order system, a piezoresistive transducer can be represented as a second order single- degree-of-freedom spring-mass system. The response is shown below as a function of frequency. This curve represents the lowest (first) mode resonant response of the complex structure.

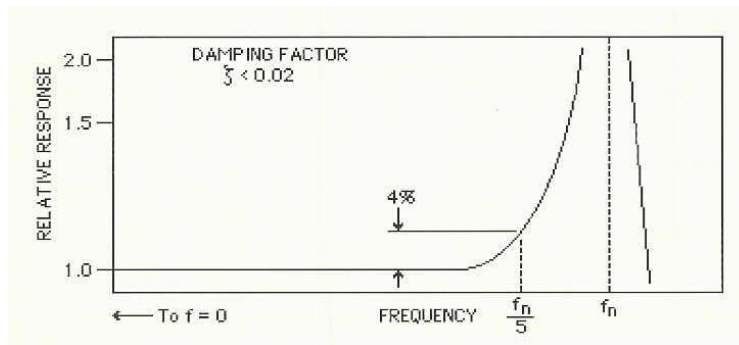

Figure 3-9: Frequency Response of a Pressure Transducer

This curve shows the variation in sensitivity of the transducer with frequency. The silicon diaphragm, because of its small mass and high stiffness, has an extremely high resonance frequency. Kulite characterises the diaphragm resonant frequencies for each design of silicon diaphragm. A rule of thumb for dynamic measurement is to select a device with a diaphragm resonant frequency at least five times the highest frequency to be measured. This is not usually a problem as for a typical Kulite miniature pressure transducer, the resonant frequency for a 5psi range unit is 160kHz rising to 1250kHz for a 2000psi unit.

3.10. Frequency Response

Kulite's piezoresistive pressure transducers are capable of response from steady state to frequencies into the ultrasonic range, and of response to fast rise time transient inputs. The sensing chip is generally mounted at the front of the transducer, making it equivalent to a flush-mounted diaphragm for most applications. The protective screen over the sensing surface has been designed to not degrade performance of the gauge; however, for some applications it may be removed. These applications usually involve high speed fluid flow, high frequency response, and a need to not disturb the surface of the body in the flow. Silicone rubber (RTV) may be added to the front to smooth out the surface.

3.10.1. Rise and Response Times

Rise time is the time required for the output to rise from a small percentage to a large percentage of its final value, when excited by a step change in measurand. Unless otherwise specified the percentages are assumed to be 10% and 90%.

Response time is the time required for the output to increase from zero to some specified percentage of its final value, when excited by a step change in measurand. The 63.2% (usually rounded to 63%) response time is the 'time constant', (t).

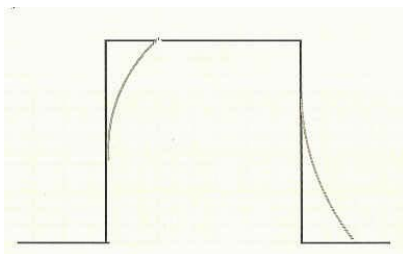

Figure 3-10: Response of First Order System to a Step Change

Technically, rise time and response time refer only to systems which are not underdamped. Piezoresistive pressure transducers are usually under damped, so using these terms is actually not

correct. The under damped system will respond very quickly, but will overshoot and oscillate for some time before reaching its final output value. The time constant is valid for any system.

For under damped systems, we can calculate the period, (t), based on natural frequency, which will cause less than 5% distortion. A transient with shorter period than (t) will cause ringing (distortion) greater than 5%.

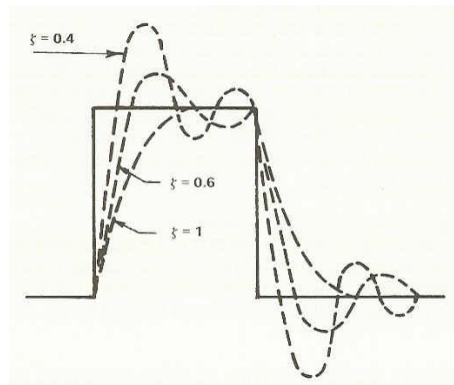

Figure 3-11: Transient Response of Second Order System with Different Damping

Piezoresistive pressure transducers provide the user with the capability of monitoring extremely rapid rise time pressure pulses. The rise time of the transducer is much faster than the period to which it will respond accurately. A rise time (t) to which the transducer will respond linearly to within +/-5%, can be expressed as a function of the period to which the transducer has a flat response (T).

$$T = 1 / 0.2 f_n$$

Where f_n = resonant frequency and $T = t/4 = 1 / 0.8 f_n$

3.11. Acceleration Sensitivity

Acceleration sensitivity is the maximum difference, at any pressure level within the specified range, between output readings taken with and without the application of specified acceleration along specified axes.

Kulite's pressure transducers, by design, are highly insensitive to acceleration inputs. Acceleration sensitivity is the sensitivity of the pressure transducer diaphragm to applied acceleration. The reaction of the device diaphragm to acceleration is a function of its stiffness, mass, thickness and diameter. Acceleration sensitivity is a function of both transducer overall diameter and pressure range. Sensitivities as low as 0.00003 % FS/g are available in the pressure sensitive directions. Therefore, for a 1000 g in-axis (worst case) acceleration input the total error might be as low as 0.03% Full Scale. Cross acceleration sensitivities are generally between a 1/5 and a 1/10 of that in the sensitive directions. Acceleration sensitivity for different pressure ranges are listed on each individual data sheet and are typical values from sample tests.

For application in extremely high acceleration or vibration environments, Kulite has designed an acceleration compensated pressure sensor which has a negligible acceleration sensitivity even when subjected to accelerations in excess of 60,000g. The acceleration compensated pressure sensor is based upon the leadless technology and is capable of operation at temperatures in excess of 500°C.

3.12. Burst Pressure

Burst pressure is the pressure which may be applied to the diaphragm, and the portion of the space subjected to the pressurised fluid medium, without rupture of the diaphragm.

This is a static pressure rating; peak pressure greater than the specified range should not be applied at frequencies greater than 30% of the resonant frequency. The resultant mechanical amplification effect near the resonant frequency may cause erroneous data, or in extreme cases may burst the diaphragm.

3.13. Full Scale Output

Full scale output is defined as transducer output from zero to + full scale (maximum range). Kulite pressure transducers have FSO of between 50mV and 200mV, depending on model with 100mV being the typical FSO. Net full scale output is the value of transducer output at the maximum rated load minus the output at the minimum rated load.

3.14. Supply Voltage or Excitation

Supply voltage or excitation is the external voltage applied to the transducer for its operation within specified tolerances.

The excitation across the piezoresistive elements causes a finite current to flow through each element. The I^2R heating results in an increase in temperature of the gages slightly above ambient, which increases the resistance of the elements. Differentials in this effect may cause the output voltage to vary slightly with time, until the temperature is stabilised. With 10 Vdc excitation, stabilisation to within 1% usually occurs within one millisecond when tested at standard barometric conditions.

Excitations other than 10 Vdc can be used with a maximum excitation of 15 Vdc usually being specified without damage.

3.15. Input/ Output Resistance

Input and output resistance are measured between input leads and between output leads with an ohmmeter using 10 volts or less applied voltage. This measurement is extremely temperature sensitive and may vary significantly with small temperature variations, The main uses of these measurements are to calculate excitation current, and to be sure the bridge is not open or shorted.

3.16. Insulation Resistance

Insulation resistance is the lowest value of resistance measured between all leads tied together and the shield, all leads tied together and the transducer case, or cable shield and transducer case. This measurement is made using a megohmmeter with 50 volts applied.